

Assembly and Installation Instructions

ATTENTION

Fixture only to be connected to a constant current (C.C.) low-voltage power source with a maximum output of 700 mA (0.7 amp), up to 48 volts. Connection to any other power source voids warranty.

Owner/User Responsibilities: It is the responsibility of the contractor, installer, buyer, owner and user to install, maintain and operate this luminaire in accordance with all laws, building codes, regulations and local Electrical Safety Authority requirements. This product is only to be installed by a qualified person.

Preparation

1. Shut off power at fuse box or circuit breaker before installation.
2. Turn off power before inspection or removal of LED light source.
3. Remove content from boxes.

Assembly

Step 1.) Assemble downrods to swivel caps at each end of the fixture, routing cable through one or both sides depending on configuration. For long downrod configurations screw multiple sections together. See Image 2.

Step 2a.) For 5 inch canopy- Attach canopies as shown in Image 3, using provided lock washer and nut.

Step 2b.) For 2 inch canopy- Attach canopies as shown in Image 4, using provided lock washer and nut.

Image 1.

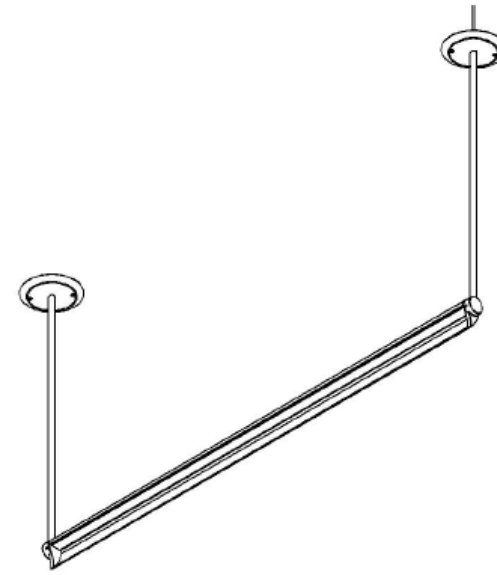

Image 2.

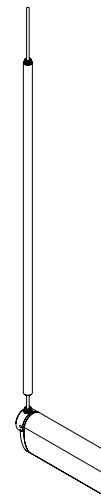

Image 3.

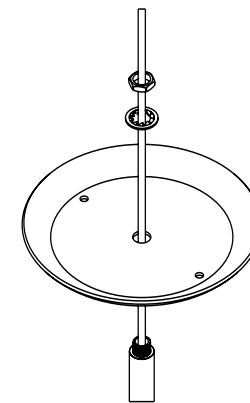
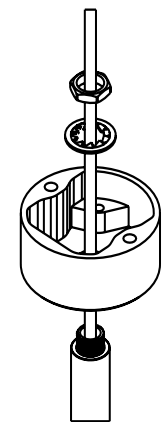

Image 4.



Installation

Step 1a.) For 5 inch canopy- (hard and tile ceiling applications) pre-install universal mounting ring to electrical box. See Image 5.

Step 1b.) For 2 inch canopy- (unistrut and architectural applications) mark and pre-drill mounting holes 1 1/2 inches apart for #8 flathead screws and/ or anchors.

Step 2.) Using either wire nuts or connectors supplied with fixture, connect the black wire lead to the (-) black negative power wire. Connect the other wire (white or red) to the (+) red positive lead. Ensure the drain wire on the incoming cable is cut or taped flush with the jacket. See Image 9.

Step 3a.) For 5 inch canopy- using provided #8-32 screws fasten canopy to universal mounting ring while ensuring no wires are pinched or damaged. See Image 6.

Step 3b.) For 2 inch canopy- If using canopy volume to contain wire splice, carefully tuck wiring connectors inside. Ensure no wires are pinched or damaged. Install #8 flathead screws into pre-drilled holes/anchors (see step 1b). Tighten to mounting surface. See Image 7.

Step 4.) Turn power on to test fixture

Step 5.) Loosen set screw and adjust angle of fixture noting position on dial indicator to ensure proper aiming of fixtures. See Image 8.

Image 5.

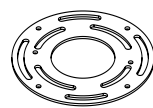

Image 8.

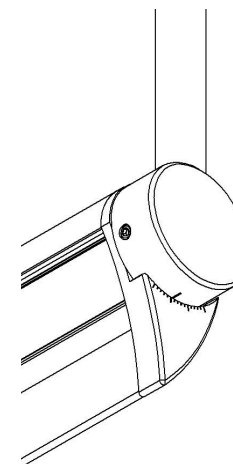

Image 7.

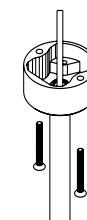

Image 6.

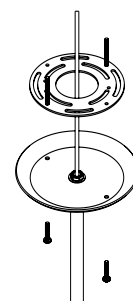
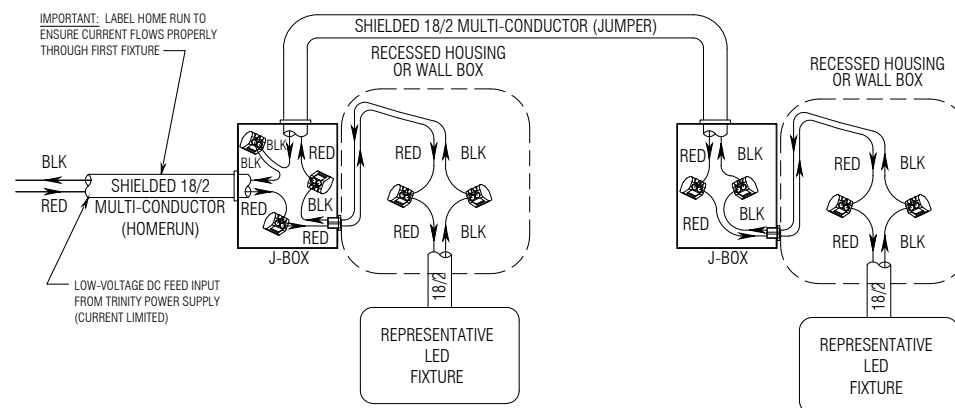

Image 9.



For more information, please contact:
+1 (727) 827-2805
sales@lumastream.com

LumaStream, Inc. reserves the right to make changes without further notice to any products herein to improve reliability, function, or design. LumaStream does not assume any liability arising out of the application or use of any product described herein; neither does it convey any license under its patent rights, nor the rights of others.

LSIG0009 / 244 Install Guide

Rev: 7/11/2016