

# Installation Instructions

## ATTENTION

Fixture to be connected **ONLY** to a **constant current (C.C.)** low-voltage power source with a maximum output of 500mA, 18 Volts per fixture channel. Connection to any other power source voids warranty.

**Owner/User Responsibilities:** It is the responsibility of the contractor, installer, buyer, owner and user to install, maintain and operate this luminaire in accordance with all laws, building codes, regulations and local Electrical Safety Authority requirements. This product is only to be installed by a qualified person.

## Preparation

Shut off power at fuse box or circuit breaker before installation or removal of fixture.

## Installation (Image 1)

1. If installing fixture into a Housing Frame:
  - A. Adjust frame Hanger Bars to fit between Joists or t-grid members. Hanger Bar Feet align with bottom of Joists/members.
  - B. If attaching to Joists, hammer pre-installed nails into Joists or fasten feet into place with screws. If attaching to t-grid ceiling, fasten feet to members with sheet metal screws.
  - C. If installing Housing Frame to Ceiling, cut 6-3/8" hole in Ceiling. (Image 2A)
2. If installing fixture directly into Ceiling, cut 6" hole in Ceiling. (Image 2B)
3. Route, connect, and secure wiring per local codes and standards. Refer to wiring diagrams on following pages for details.
4. While carefully bending Spring Clips upwards, guide fixture and wiring into hole until fixture is fully inserted.
5. Turn power on and test fixture.

Image 1)

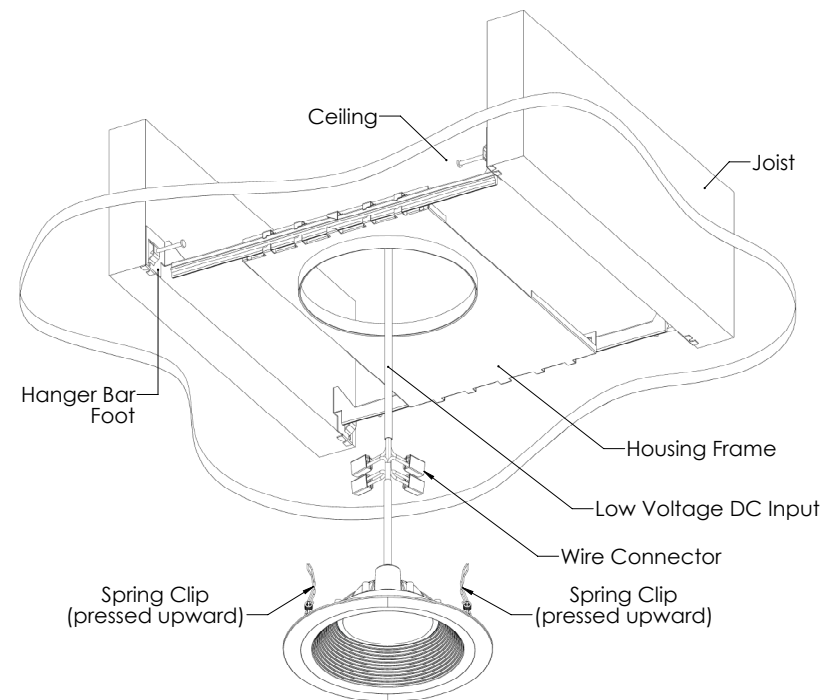

Image 2A)

WITH Housing Frame

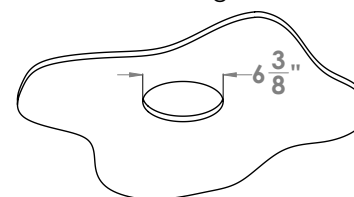
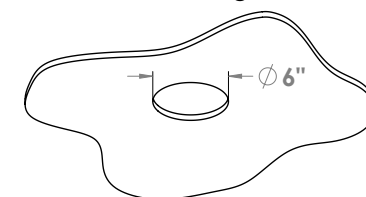

Image 2B)

WITHOUT Housing Frame



## Care and Maintenance

Clean with soft, dry cloth. Do not use abrasives.

**Wiring Diagrams: Single Fixture**

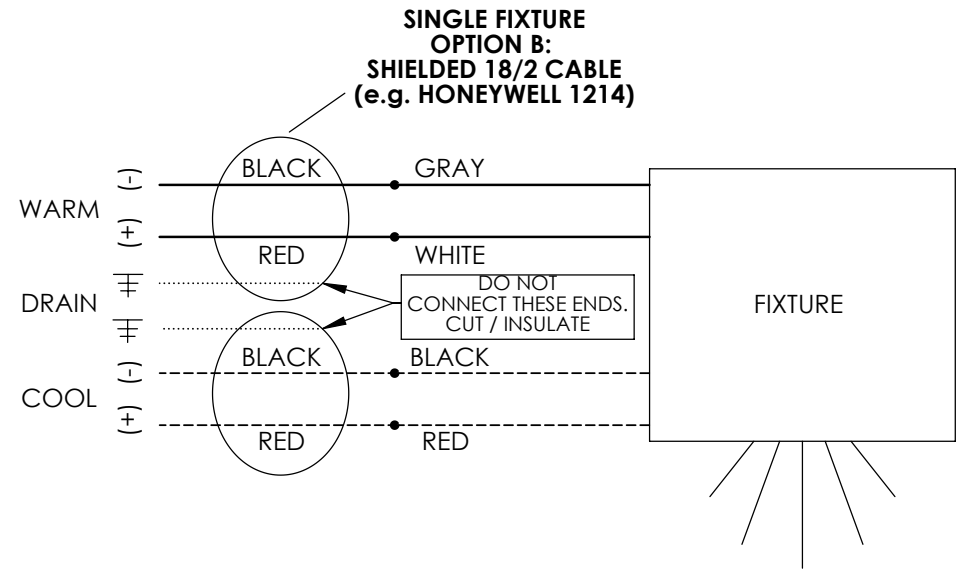
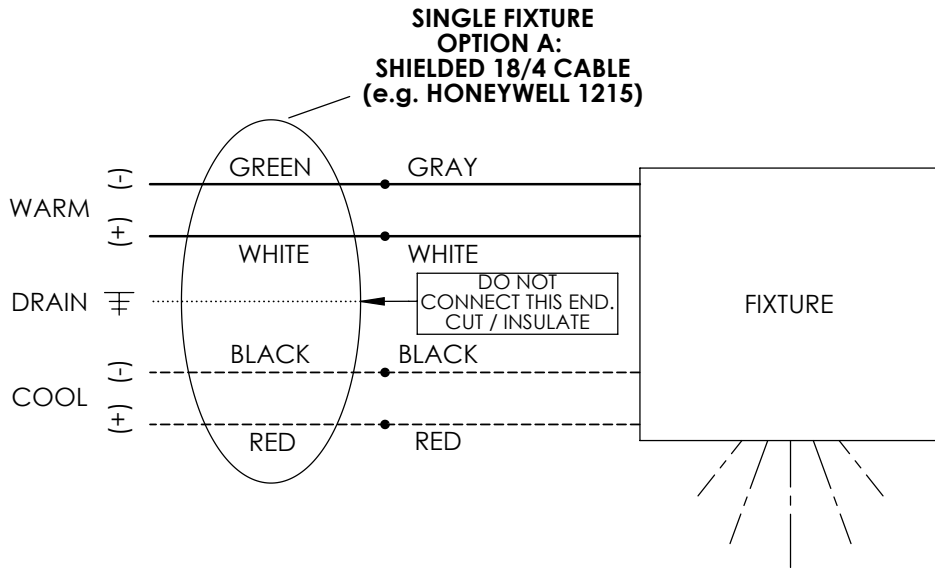

For more information, please contact:  
+1 (727) 827-2805  
sales@lumastream.com

LumaStream, Inc. reserves the right to make changes without further notice to any products herein to improve reliability, function, or design. LumaStream does not assume any liability arising out of the application or use of any product described herein; neither does it convey any license under its patent rights, nor the rights of others.

## Wiring Diagrams: Two Fixtures in Series

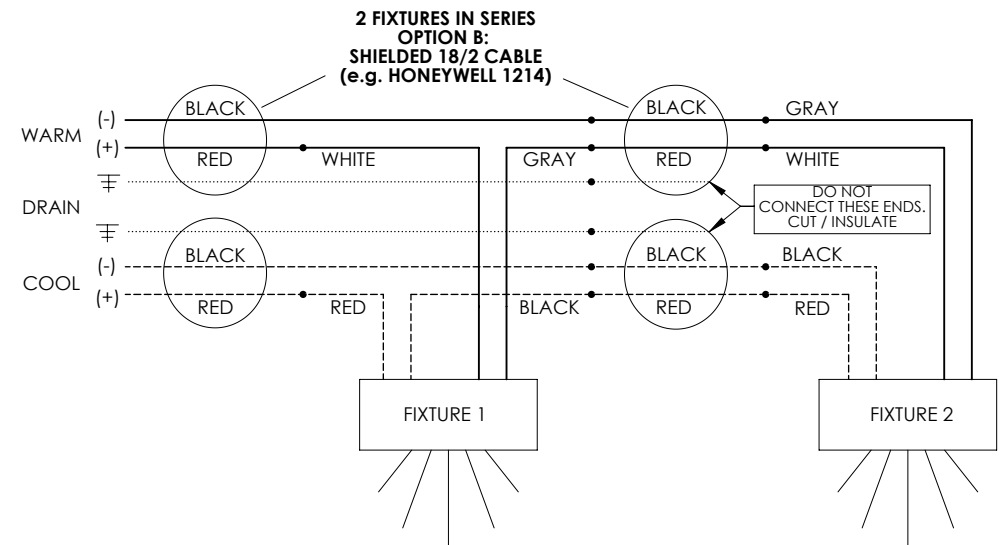
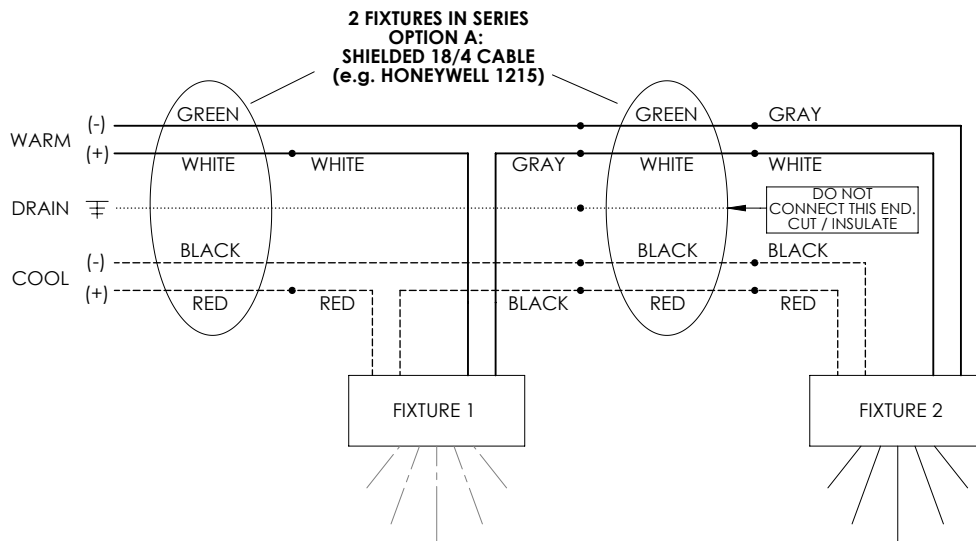

For more information, please contact:  
+1 (727) 827-2805  
sales@lumastream.com

LumaStream, Inc. reserves the right to make changes without further notice to any products herein to improve reliability, function, or design. LumaStream does not assume any liability arising out of the application or use of any product described herein; neither does it convey any license under its patent rights, nor the rights of others.